



Fertilizing Systems

Fertilize Responsibly™

INSTALLATION AND OPERATING GUIDE HC SYSTEMS



*** IMPORTANT ***

**PLEASE READ INSTRUCTIONS AND VERIFY PARTS
BEFORE INSTALLING THE SYSTEM.**

Do not connect to an irrigation system that is not protected by an approved back flow prevention device such as a pressure vacuum breaker or reduced pressure zone back flow preventer.

Do not install if pressure exceeds 100 PSI

Follow all local plumbing codes

Use only with non-hazardous products

Minimize exposure to direct sunlight to maximize service life

Protect against impact from foreign objects

All EZ-FLO systems have been specifically designed and engineered to be installed by a professional irrigation or landscape contractor. Improper installation or use could cause risk of water contamination due to back flow or tank rupture. Failure to follow all safety instructions and warnings could result in serious bodily injury. Improper installation or use of the system voids all warranties.

FOR ASSISTANCE OR FERTILIZER AVAILABILITY

CALL TOLL FREE 1-866-393-5601

OR VISIT OUR WEBSITE AT

www.ezflorfertilizing.com

(Installer - Please leave this with property owner)

© 2005, EZ-FLO Fertilizing Systems

HC TANK ASSEMBLY & PARTS LIST

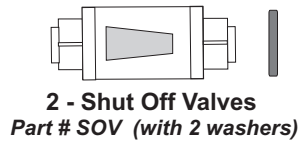
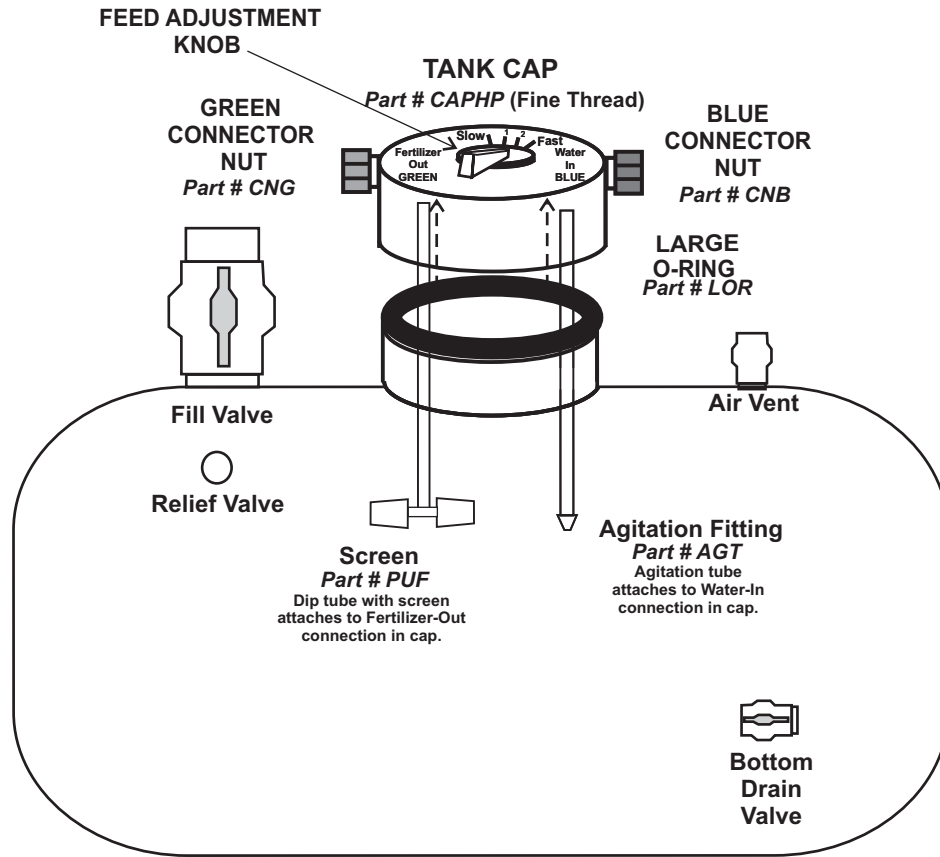

5- Feet 1/4" Black Tubing
Part # BT5

5- Feet 1/4" Clear Tubing
Part # CT5

Use EZ-FLO components only.

© 2005, EZ-FLO Fertilizing Systems

System Installation

Typical installation

The system is normally installed in a valve box, connected to the main line of the irrigation system after the back flow preventer and before the sprinkler valves. One unit will feed both drip and sprinkler zones that are downstream from the connection point.

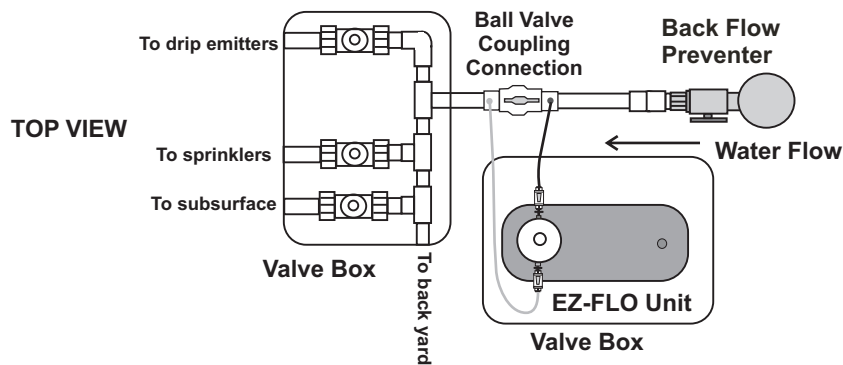

Step 1 - Locate the installation point.

Connection must be made after an approved back flow prevention device. It is preferable to have the tank cap above the installation point in the sprinkler line if possible but it is not required for efficient operation. The connection can be made either vertically or horizontally in the sprinkler main line.

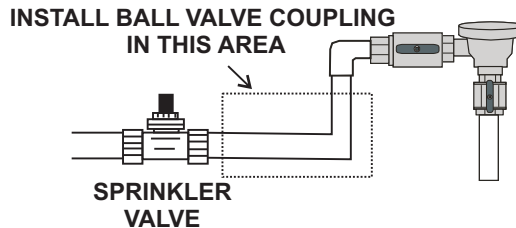

Step 2 - Shut off water by closing a valve at the back flow preventer or in the main line upstream from the connection point. Relieve the pressure from the line at the exhaust valve on the back flow preventer or by manually opening a sprinkler valve.

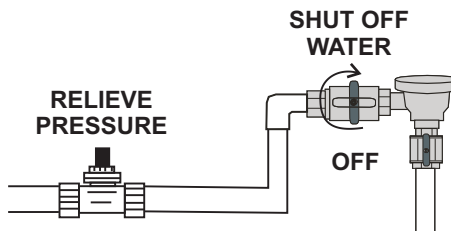

Ball Valve Coupling sold separately

Step 3 - Cut out a section of pipe slightly larger than the cut out length of the ball valve coupling. Determine the length of the cutout by measuring the length from socket to socket inside the ball valve coupling. If the space for the coupling is cut too large it may prevent the pipe and the coupling from forming a solid seal. (Unions may be used for easier retrofit installations.)

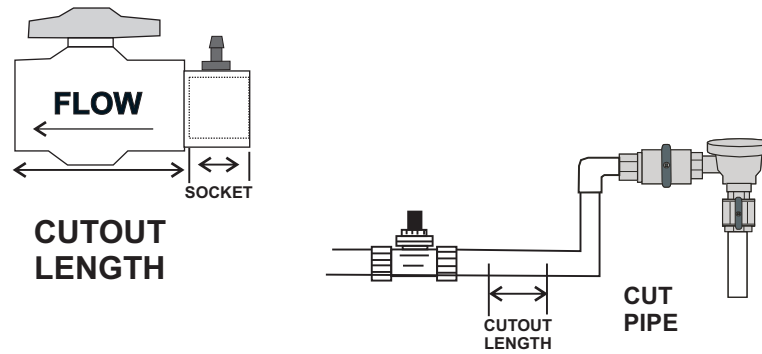

Step 4 - Glue the ball valve coupling into the line. The pipe should fit into both ends of the ball valve coupling and seat against the ball valve coupling socket. Be sure that the blue fitting is closer to the back flow preventer than the green fitting and that the flow direction of the water matches the flow direction arrow on the side of the ball valve coupling.

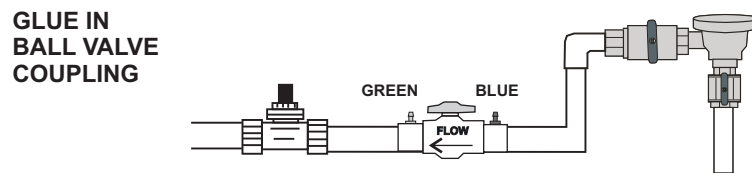

Step 5 - Attach tubing to the ball valve coupling. Press the black tube over the blue fitting on the ball valve coupling. Press the clear tube over the green fitting on the ball valve coupling. Put tubing clamps over the tubing below the barbed end of the fitting and squeeze them until they are tightly secured.

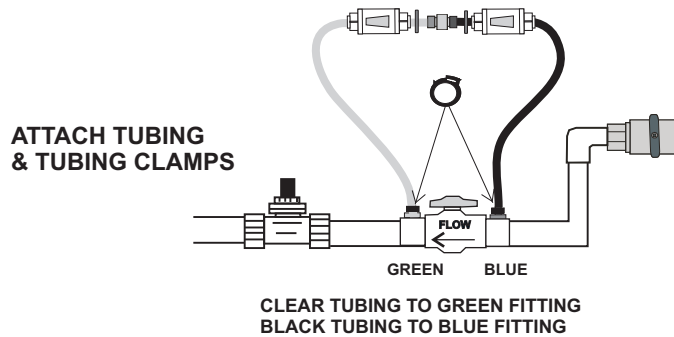

Connect System to Irrigation Lines

Step 6 - Connect tubing to tank cap by removing the blue and green connector nuts from the bypass fitting by turning them in a counter clockwise direction. (Attach bypass fitting to tubing for later use). Connect the blue connector nut to the water in side of the tank cap. Connect the green connector nut to the fertilizer out connection on the cap. Turn the water on to the system.

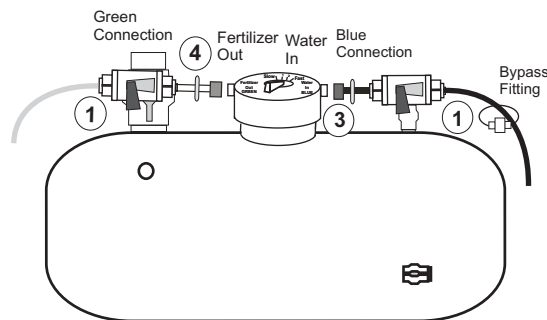

Connect tubing to cap

1. Shut off valves in the off position
2. Turn water on at back flow preventer
3. Connect blue connector to water in connection on cap
4. Connect green connector to fertilizer out connection on cap.

Fill Tank With Fertilizer

Step 7 - Fill tank with fertilizer. (For detailed instructions for refilling the system, please see the Quick Refill Guides.)

The EZ-FLO system can be filled with any liquid or water soluble fertilizer.

Before filling:

Make sure the shut off valves are off. Open the fill valve on top of the tank and make sure the drain valve on the bottom of the tank is closed.

If you do not have a High Capacity Funnel Fill System, pour fertilizer directly into tank through the fill valve, adding water periodically by opening one of the shut off valves. **When the tank is full of fertilizer, top it off with water until all air is gone from the tank.**

Model	Tank Size	Recommended Amount
EZ010HC	10 Gallon	75-100 lbs dry or 10 gal. liquid
EZ017HC	17.5 Gallon	125-175 lbs dry or 17.5 gal liquid
EZ025HC	25 Gallon	200-250 lbs dry or 25 gal liquid

If you have a High Capacity Funnel Fill System, put the funnel in the fill valve. Disconnect one of the shut off valves from the cap and connect it to the tubing on the funnel. **Open the shut off valve and pour the fertilizer into the funnel until the tank is full of liquid - all air must be out of the tank.**

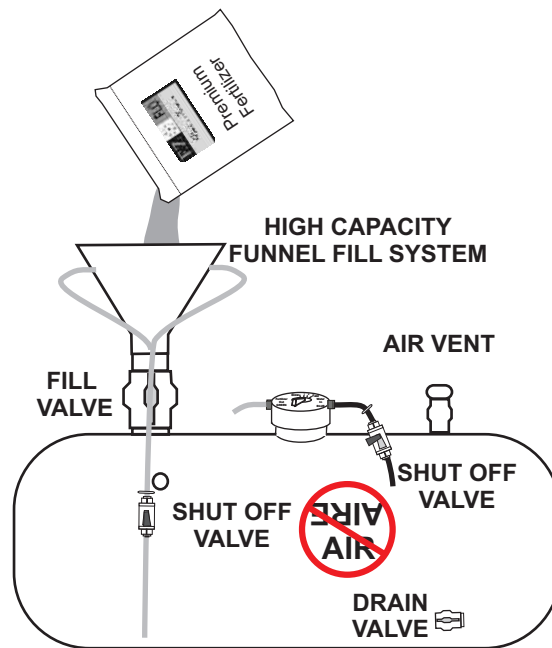

After filling:

Close the fill valve, the shut off valve and the drain/fill valve. Disconnect the shut off valve from the funnel and connect it to tank cap. Remove the fill funnel and turn both shut off valves to the on position.

Set Flow Adjustment

Step 8 - Set the flow rate by adjusting the ball valve coupling and the adjustment knob on the tank cap. (The ball valve coupling will only require adjustment at initial startup.)

1. With the cap adjustment setting in the fast position, turn on the sprinkler or drip zone with the lowest gallons per minute flow rate.
2. Slowly close the ball valve very slightly, until you can see fluid movement or color in the clear fertilizer out line.
3. Set the cap adjustment knob to the desired feed rate.
4. Turn off the sprinkler or drip zone.

Slow Setting - is used for normal maintenance in regions with high watering requirements such as hot dry climates or sandy soils.

#1 Setting - is used for normal maintenance in regions with more moderate climates and moderate watering schedules where soils have good moisture retention.

#2 Setting - is used to encourage fast growth or to quickly improve the condition of a landscape in poor condition. The unit will empty more quickly and can be refilled more often.

Fast Setting - is used to for periodic fertilization. The unit will empty more quickly and can be refilled more often.

Setting	*Ratio	OZ. of fertilizer per gal. of water
Slow	15000:1	.008 (1/20 tsp)
1	8000:1	.017 (1/10 tsp)
2	2000:1	.064 (2/5 tsp)
Fast	400:1	.320 (2 tsp)

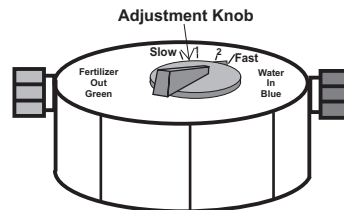

*Ratio refers to the amount of water mixed with the fertilizer. For example, a 400:1 ratio means 400 gallons of water will be mixed with 1 gallon of fertilizer. The adjustment knob can be set in between settings if desired.

Gallons Of Water Required To Distribute Fertilizer

The following table shows the gallons of water required to distribute the fertilizer from the EZ-FLO High Capacity System at the various flow settings.

Model	EZ010	EZ017	EZ025
Slow	150,000	300,000	450,000
1	80,000	160,000	240,000
2	20,000	40,000	60,500
Fast	4,000	8,000	12,000

How It Works

Your system is now ready to operate. Each time you water, the EZ-FLO system will proportion small amounts (micro doses) of fertilizer in the irrigation water. The patented flow process evenly meters fertilizer from start to finish. Fill based on desired results.

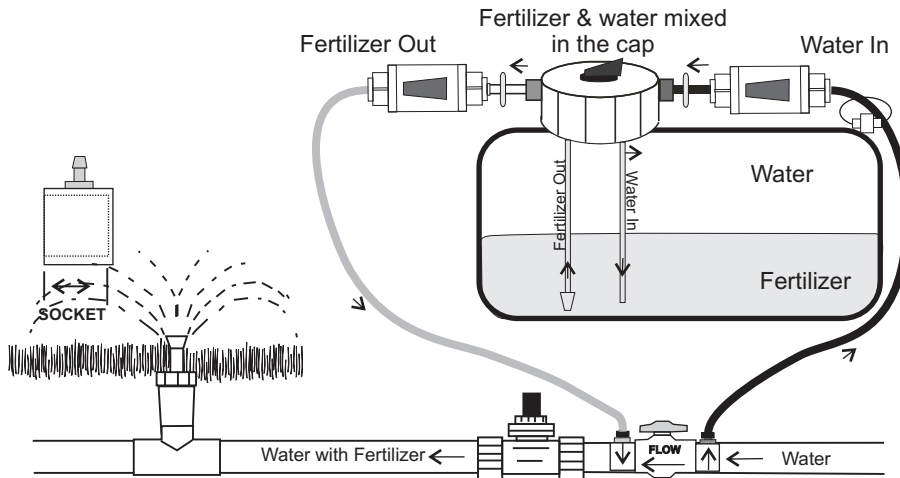

Water entering the tank is layered over the top of the fertilizer that settles to the bottom of the tank. Fertilizer is drawn from the bottom of the tank, out the clear tubing and into the irrigation system. EZ-FLO's patented technology ensures consistent metering from start to finish.

Winterizing Your System

**** CAUTION - DO NOT USE AIR TO BLOW OUT YOUR SPRINKLER SYSTEM **
** WITH THE EZ-FLO SYSTEM ATTACHED ****

If you live in a region where winter temperatures can drop below freezing it is necessary to winterize your system.

System with shut off valves

1. Turn valves to off position
2. Remove blue and green connectors from the tank cap
3. Screw blue and green connectors onto bypass fitting
4. Drain tank and return it to the valve box or store in garage

If you need assistance with the installation or operation of your system, or have further questions, please visit our web site at www.ezflofertilizing.com or call **EZ-FLO toll free at (866)393-5601**.

For warranty provisions for this unit, please refer to www.ezflofertilizing.com/warranty.asp or call toll free at **(866)393-5601**.