

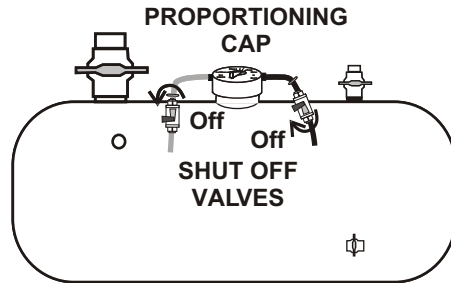

Quick Refill Guide For Water Soluble Fertilizers

Keep This for Future Reference

Step 1. Turn off water by closing the shut off valves that feed in and out of the proportioning cap.



Step 2 - Relieve tank pressure by opening the top drain/vent valve.

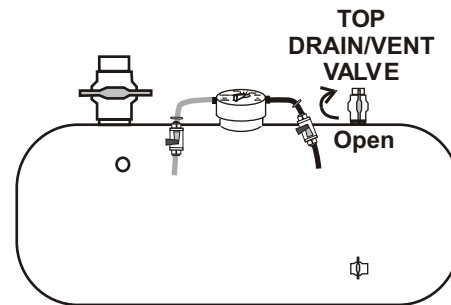

Step 3 - Drain tank

The tank can be drained by opening the bottom drain valve at the bottom of the tank or through the top drain/vent valve at the top of the tank as the tank is refilled with fertilizer. Tubing is provided to attach to the top drain/vent valve if you choose to drain in this manner.

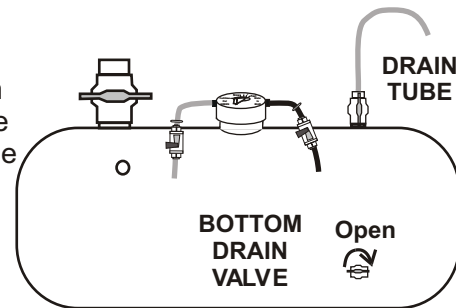

Step 4 - Close the bottom drain valve and open the fill valve.

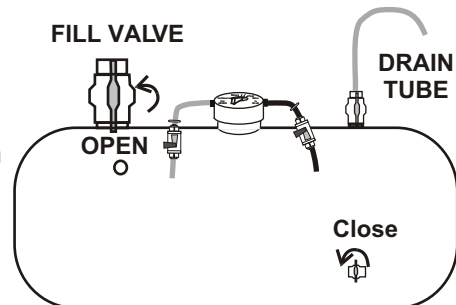

Quick Refill Guide For Water Soluble Fertilizers

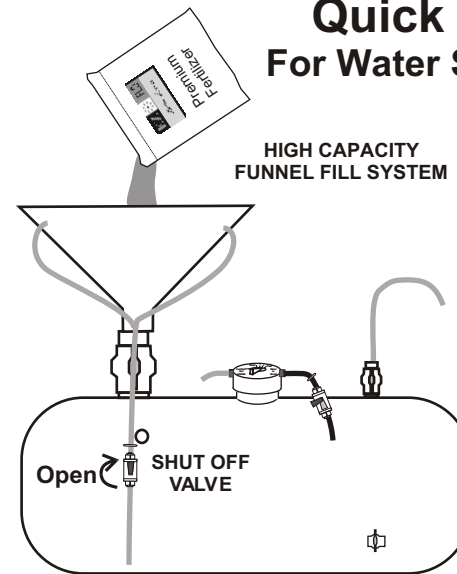

Step 5 - Fill tank with fertilizer.

If you have the high capacity funnel fill system:

1. Insert the funnel in the fill valve.
2. Disconnect one shut off valve from the tank cap and connect it to the funnel.
3. Open the valve to start water flow into the funnel.
4. Pour in fertilizer until the tank is full.

If you do not have the high capacity funnel fill system:

1. Pour the fertilizer through the fill valve.
2. Disconnect one shut off valve from the tank cap and use it to add water to the fertilizer as you pour the fertilizer into the tank.
3. Pour in fertilizer until the tank is full.

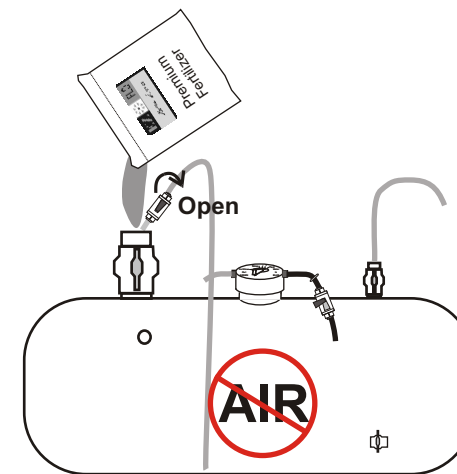

Purge All Air - Fill tank until water overflows to ensure all air is out of the tank or tank failure could result.

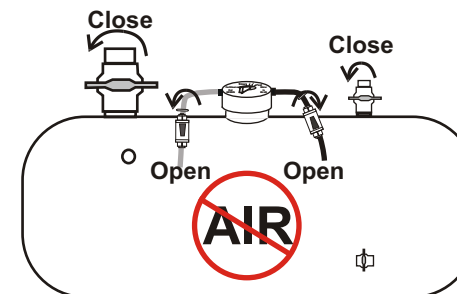

Step 6 - After filling

1. Remove funnel and close the fill and drain valves.
2. Connect both shut off valves to the tank cap and turn them to the on position.



Quick Refill Guide For Liquid Fertilizers

Keep This for Future Reference

- Step 1.** Turn off water by closing the shut off valves that feed in and out of the proportioning cap.

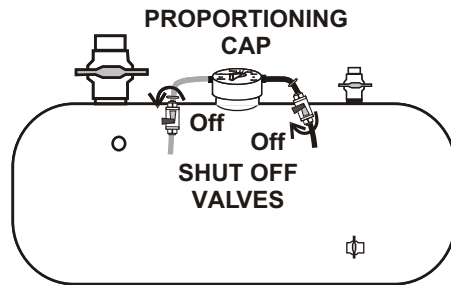

- Step 2 -** Relieve tank pressure by opening the top drain/vent valve.

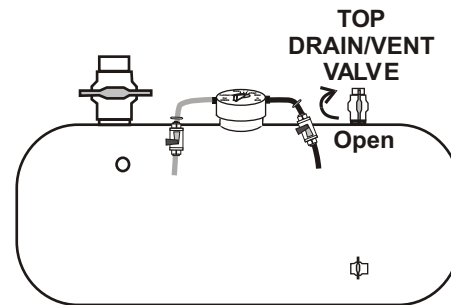

Step 3 - Drain tank

The tank can be drained by opening the bottom drain valve at the bottom of the tank or through the top drain/vent valve at the top of the tank as the tank is refilled with fertilizer. Tubing is provided to attach to the top drain/vent valve if you choose to drain in this manner.

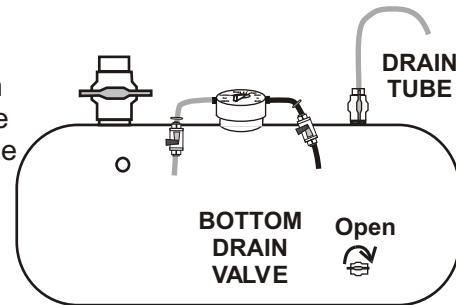

- Step 4 -** Close the bottom drain valve and open the fill valve.

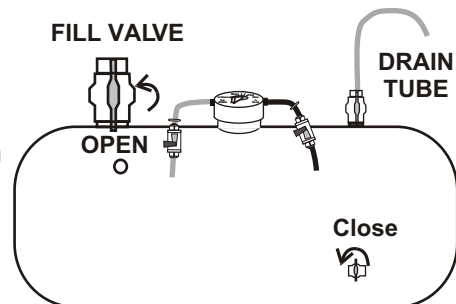

Quick Refill Guide For Liquid Fertilizers

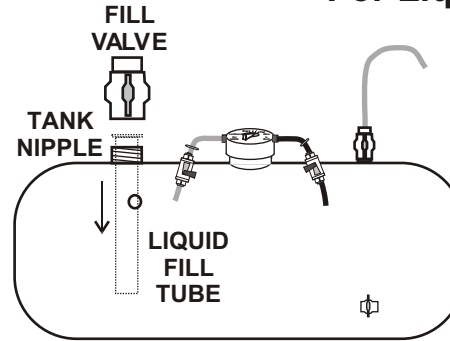

- Step 5 -** Install the liquid fill tube. (Required only if draining from the drain valve on top of the tank. Sold separately.)

1. Remove the fill valve.
2. Insert the liquid fill tube into the fill valve until it sets on the tank nipple.
3. Reconnect the fill valve to the tank nipple.

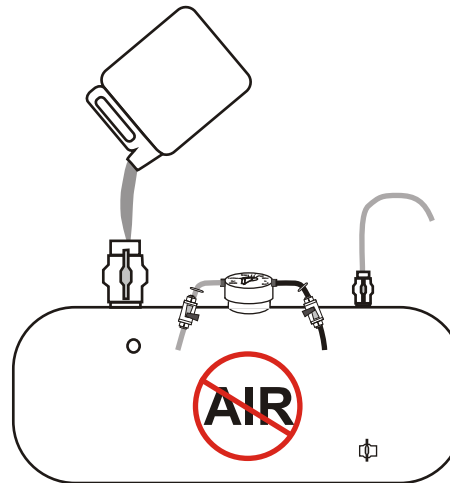

Step 6 - Fill tank with fertilizer.

1. Pour in fertilizer through the fill valve.
2. Water will drain from the top drain/vent valve (if this draining option was chosen).
3. The tank is full when you can see fertilizer coming out through the drain tube.

Purge All Air - Fill tank until water overflows to ensure all air is out of the tank or tank failure could result.

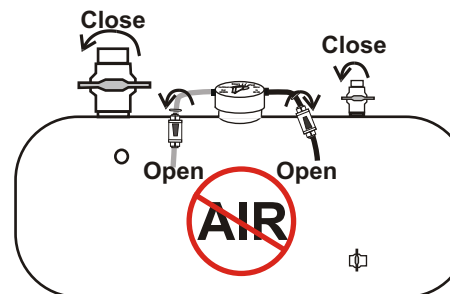

Step 7 - After filling

1. Close the fill and drain valves.
2. Turn both shut off valves to the on position.